

FEIDER

MACHINES



CORDLESS DRILL 18V 4 IN 1

FPVSS18V4IN1

USER GUIDE

CAUTION: Read this manual before using this machine!

CONTENTS

1. INTENDED USE.....	3
2. SAFETY INSTRUCTIONS.....	3
3. YOUR PRODUCT.....	10
4. PACKAGE CONTENT LIST.....	11
5. TECHNICAL DATA.....	11
6. OPERATION.....	12
7. CLEANING AND MAINTENANCE.....	17
8. STORAGE.....	17
9. DISPOSAL.....	17
10. DECLARATION OF CONFORMITY.....	18
11. WARRANTY.....	19
12. PRODUCT FAILURE.....	20
13. WARRANTY EXCLUSIONS.....	21

1. INTENDED USE

The cordless tool of 18 V 4 in 1 is intended for

- 1) Screwing screws in and out and for drilling holes in wood, metal or plastic.
- 2) Sawing wood, metal and plastics
- 3) Dry sanding of wood, plastic, putty and painting surfaces or varnished. This product is not suitable for sanding plaster-based substrates.

The tool is not suitable for commercial use. Any other use that is not explicitly approved in these instructions may result in damage to the equipment and represent a serious danger to the user.

The tool is designed for use by adults. Adolescents over the age of 16 may use the device only under supervision. The manufacturer is not liable for damages caused by unspecified use or incorrect operation.



WARNING! For your own safety, read this manual and the general safety instructions carefully before using the appliance. Your power tool should only be given to other users together with these instructions.

2. SAFETY INSTRUCTIONS

2.1 GENERAL POWER TOOL SAFETY WARNINGS



WARNING! Read all safety warnings, instructions, illustrations and specifications provided with this power tool. Failure to follow all instructions listed below may result in electric shock, fire and/or serious injury.

Save all warnings and instructions for future reference.

The term "power tool" in the warnings refers to your mains-operated (corded) power tool or battery-operated (cordless) power tool.

1) Work area safety

- a) **Keep work area clean and well lit.** Cluttered or dark areas invite accidents.
- b) **Do not operate power tools in explosive atmospheres, such as in the presence of flammable liquids, gases or dust.** Power tools create sparks which may ignite the dust or fumes.
- c) **Keep children and bystanders away while operating a power tool.** Distractions can cause you to lose control.

2) Electrical safety

- a) **Power tool plugs must match the outlet. Never modify the plug in any way. Do not use any adapter plugs with earthed (grounded) power tools.** Unmodified plugs and matching outlets will reduce risk of electric shock.
- b) **Avoid body contact with earthed or grounded surfaces, such as pipes, radiators, ranges and refrigerators.** There is an increased risk of electric shock if your body is earthed or grounded.
- c) **Do not expose power tools to rain or wet conditions.** Water entering a power tool will increase the risk of electric shock.

d) **Do not abuse the cord. Never use the cord for carrying, pulling or unplugging the power tool. Keep cord away from heat, oil, sharp edges or moving parts.** *Damaged or entangled cords increase the risk of electric shock.*

e) **When operating a power tool outdoors, use an extension cord suitable for outdoor use.** *Use of a cord suitable for outdoor use reduces the risk of electric shock.*

f) **If operating a power tool in a damp location is unavoidable, use a residual current device (RCD) protected supply.** *Use of an RCD reduces the risk of electric shock.*

3) Personal safety

a) **Stay alert, watch what you are doing and use common sense when operating a power tool. Do not use a power tool while you are tired or under the influence of drugs, alcohol or medication.** *A moment of inattention while operating power tools may result in serious personal injury.*

b) **Use personal protective equipment. Always wear eye protection.** *Protective equipment such as a dust mask, non-skid safety shoes, hard hat or hearing protection used for appropriate conditions will reduce personal injuries.*

c) **Prevent unintentional starting. Ensure the switch is in the off-position before connecting to power source and/or battery pack, picking up or carrying the tool.** *Carrying power tools with your finger on the switch or energising power tools that have the switch on invites accidents.*

d) **Remove any adjusting key or wrench before turning the power tool on.** *A wrench or a key left attached to a rotating part of the power tool may result in personal injury.*

e) **Do not overreach. Keep proper footing and balance at all times.** *This enables better control of the power tool in unexpected situations.*

f) **Dress properly. Do not wear loose clothing or jewellery. Keep your hair and clothing away from moving parts.** *Loose clothes, jewellery or long hair can be caught in moving parts.*

g) **If devices are provided for the connection of dust extraction and collection facilities, ensure these are connected and properly used.** *Use of dust collection can reduce dust-related hazards.*

h) **Do not let familiarity gained from frequent use of tools allow you to become complacent and ignore tool safety principles.** *A careless action can cause severe injury within a fraction of a second.*

4) Power tool use and care

a) **Do not force the power tool. Use the correct power tool for your application.** *The correct power tool will do the job better and safer at the rate for which it was designed.*

b) **Do not use the power tool if the switch does not turn it on and off.** *Any power tool that cannot be controlled with the switch is dangerous and must be repaired.*

c) **Disconnect the plug from the power source and/or remove the battery pack, if detachable, from the power tool before making any adjustments, changing accessories, or storing power tools.** *Such preventive safety measures reduce the risk of starting the power tool accidentally.*

d) **Store idle power tools out of the reach of children and do not allow persons unfamiliar with the power tool or these instructions to operate the power tool.**

Power tools are dangerous in the hands of untrained users.

e) **Maintain power tools and accessories. Check for misalignment or binding of moving parts, breakage of parts and any other condition that may affect the power tool's operation. If damaged, have the power tool repaired before use.** *Many accidents are caused by poorly maintained power tools.*

- f) **Keep cutting tools sharp and clean.** *Properly maintained cutting tools with sharp cutting edges are less likely to bind and are easier to control.*
- g) **Use the power tool, accessories and tool bits etc. in accordance with these instructions, taking into account the working conditions and the work to be performed.** *Use of the power tool for operations different from those intended could result in a hazardous situation.*
- h) **Keep handles and grasping surfaces dry, clean and free from oil and grease.** *Slippery handles and grasping surfaces do not allow for safe handling and control of the tool in unexpected situations.*

5) Battery tool use and care

- a) **Recharge only with the charger specified by the manufacturer.** *A charger that is suitable for one type of battery pack may create a risk of fire when used with another battery pack.*
- b) **Use power tools only with specifically designated battery packs.** *Use of any other battery packs may create a risk of injury and fire.*
- c) **When battery pack is not in use, keep it away from other metal objects, like paper clips, coins, keys, nails, screws or other small metal objects, that can make a connection from one terminal to another.** *Shorting the battery terminals together may cause burns or a fire.*
- d) **Under abusive conditions, liquid may be ejected from the battery; avoid contact. If contact accidentally occurs, flush with water. If liquid contacts eyes, additionally seek medical help.** *Liquid ejected from the battery may cause irritation or burns.*
- e) **Do not use a battery pack or tool that is damaged or modified.** *Damaged or modified batteries may exhibit unpredictable behaviour resulting in fire, explosion or risk of injury.*
- f) **Do not expose a battery pack or tool to fire or excessive temperature.** *Exposure to fire or temperature above 130 °C may cause explosion.*
- g) **Follow all charging instructions and do not charge the battery pack or tool outside the temperature range specified in the instructions.** *Charging improperly or at temperatures outside the specified range may damage the battery and increase the risk of fire.*

6) Service

- a) **Have your power tool serviced by a qualified repair person using only identical replacement parts.** *This will ensure that the safety of the power tool is maintained.*
- b) **Never service damaged battery packs.** *Service of battery packs should only be performed by the manufacturer or authorized service providers.*

2.2 SAFETY INSTRUCTIONS FOR BATTERIES AND CHARGER

Batteries

- Never attempt to open for any reason.
- Do not store in locations where the temperature may exceed 40°C (104°F).
- Charge only at ambient temperatures between 4°C and 40°C (39.2°F and 104°F).
- Charge only using the charger provided with the tool.
- Store your batteries in a cool dry place (5°C-20°C/41°F-68°F). Never store batteries in discharged state.
- It is better for Li-ion batteries to discharge and reload them regularly (at least 4 times a year). The ideal charge for long-term storage of your Li-ion battery is 40% of capacity.
- When disposing of batteries, follow the instructions given in the section "Protecting the environment".

- Do not cause short circuits. If connection is made between the positive (+) and negative (-) terminal directly or via accidental contact with metallic objects, the battery is short circuited and an intense current will flow causing heat generation which may lead to casing rupture or fire.
- Do not heat. If batteries are heated to above 100°C (212°F), sealing and insulating separators and other polymer components may be damaged resulting in electrolyte leakage and/or internal short circuiting leading to heat generation causing rupture or fire. Moreover do not dispose of the batteries in fire, explosion and/or intense burning may result.
- Under extreme conditions, battery leakage may occur. When you notice liquid on the battery, proceed as follows:
 - ✓ Carefully wipe the liquid off using a cloth. Avoid skin contact.
 - ✓ In case of skin or eye contact, follow the instructions below:
 - Immediately rinse with water. Neutralize with a mild acid such as lemon juice or vinegar.
 - In case of eye contact, rinse abundantly with clean water for at least 10 minutes. Consult a physician.



Fire hazard! Avoid short-circuiting the contacts of a detached battery. Do not incinerate the battery.

Charger

- This charger can be used by children aged from 8 years and above and persons with reduced physical, sensory or mental capabilities or lack of experience and knowledge if they have been given supervision or instruction concerning use of the charger in the safe way and understand the hazards involved. Children shall not play with the charger. Cleaning and user maintenance of the charger shall not be made by children without adult supervision.
- If the supply cord is damaged, it must be replaced by the manufacturer, its service agent or similarly qualified persons in order to avoid a hazard.
- To charge the battery, use only the charger supplied.
- Never charge non-rechargeable batteries.

- During charging the batteries must be placed in a well ventilated area.

2.3 ADDITIONAL SAFETY INSTRUCTIONS



WARNING! Sawing or sanding can result in the formation of hazardous dusts (e.g. arising from materials with paints containing lead, materials containing asbestos, metals or some wood types) which can present a hazard to the operator or persons in the vicinity. Make sure that the workplace is well ventilated. Always wear safety goggles, safety gloves and respiratory protection. Attach a dust extraction system.

2.4 SAFETY INSTRUCTIONS FOR RECIPROCATING SAWS

Hold the power tool by insulated gripping surfaces, when performing an operation where the cutting accessory may contact hidden wiring. *Cutting accessory contacting a "live" wire may make exposed metal parts of the power tool "live" and could give the operator an electric shock.*

Use clamps or another practical way to secure and support the workpiece to a stable platform. *Holding the workpiece by hand or against your body leaves it unstable and may lead to loss of control.*

2.5 SPECIAL SAFETY INFORMATION FOR THE CORDLESS COMBINATION TOOL

- **Hold the electric tool by the insulated handle surfaces when performing work where the cutting tool or screw may come into contact with hidden wiring.** *Contact with a live wire can also cause a charge in metal parts of the appliance and result in an electric shock.*
- **Use suitable detectors in order to find hidden supply lines or ask the local utility company.** *Contact with electrical cables can lead to electric shock and fire, contact with a gas pipe can result in an explosion. Damage to a water pipe can lead to property damaged and electric shock.*
- **Secure the workpiece.** *A workpiece that is retained with clamping appliances or a vice is held more securely than with your hand.*
- **Be very careful when handling tools such as saws, scraper blades and drills.** *These are sharp and present an injury hazard.*
- **Wear safety gloves when changing attachments.** *This enables you to avoid injuries if the appliance attachment has heated up after use.*

2.6 SPECIFIC SAFETY INSTRUCTIONS WHEN SAWING

- **Keep hands away from the sawing area. Do not reach underneath the workpiece.** *Always stand to the side of the saw when working. Upon contact with the blade there is a risk of injury.*
- **Only when the electric tool is turned on should the sawing blade be moved against the workpiece.** *There is a risk of kickback if the tool insert jams in the workpiece.*
- **Make sure that the footplate is securely placed against the workpiece during sawing.** *The sawblade can tilt and lead to loss of control over the power tool.*
- **After you have finished work, turn the power tool off and do not pull the sawblade out of the cut until it has come to a standstill.** *In this way you will avoid any kickback and can safely put down the*

power tool.

- **Use only undamaged sawblades in perfect condition.** *Bent or blunt blades can break, adversely affect the cut or cause kickback.*
- **Do not brake the sawblade after applying side pressure.** *The sawblade may be damaged, break or cause switching the appliance off by a kickback.*
- **Tighten the material firmly. Do not support the workpiece by hand or foot. Do not touch any objects or the ground with the saw running.**
- **There is a risk of kickback. Hold the power tool tightly with both hands while working and ensure a secure footing.** *The power tool is guided more securely with both hands.*
- **Wait until the power tool has stopped before placing it down.** *The tool insert can tilt and lead to loss of control over the power tool.*
- **Switch the appliance off immediately if the sawing blade jams.** *Spread the saw cut out and pull the blade out carefully. This can lead to loss of control over the power tool.*

2.7 SPECIAL SAFETY INFORMATION DURING SANDING AND SCRAPING

- **Only use the power tool for dry sanding. Do not scrape moist materials.** *Penetration of water into the power tool increases the risk of electric shock.*
- **Avoid overheating the sanded object and the sander itself.** *Possible fire hazard.*
- **The workpiece gets hot during grinding. Do not touch the machined area, allow it to cool down.** *There is a risk of burning. Do not use coolants or the like.*
- **Always empty the dust container before work breaks.** *Sanding dust in the dust sack, micro filter, paper sack (or in the filter sack or extraction system filter) can self-ignite under unfavourable conditions such as lying sparks caused by grinding metals. Particular hazards are caused if the sanding dust is mixed with paint, polyurethane residues or other chemical substances, or if the sanded object is hot after long working periods.*

2.8 SAFETY WARNINGS FOR DRILLS

a) Safety instructions for all operations

- **Wear ear protectors when impact drilling.** *Exposure to noise can cause hearing loss.*
- **Hold the power tool by insulated gripping surfaces, when performing an operation where the cutting accessory may contact hidden wiring.** *Cutting accessory contacting a "live" wire may make exposed metal parts of the power tool "live" and could give the operator an electric shock.*

b) Safety instructions when using long drill bits













- **Never operate at higher speed than the maximum speed rating of the drill bit.** *At higher speeds, the bit is likely to bend if allowed to rotate freely without contacting the workpiece, resulting in personal injury.*
- **Always start drilling at low speed and with the bit tip in contact with the workpiece.** *At higher speeds, the bit is likely to bend if allowed to rotate freely without contacting the workpiece, resulting in personal injury.*
- **Apply pressure only in direct line with the bit and do not apply excessive pressure.** *Bits can bend causing breakage or loss of control, resulting in personal injury.*

2.9 RESIDUAL RISKS

Even if properly operating and handling this electric tool, some residual risks will remain. Due to its construction and build, this electric tool may present the following hazards:

- a) Lung damage, if suitable respiratory protection is not worn;
- b) Cuts
- c) Ear damage if working without ear protection.
- d) Eye damage if suitable eye protection is not worn.
- e) Damage to your health caused by swinging your hands and arms when operating the appliance for longer periods of time or if the unit is not held or maintained properly.

2.10 SYMBOLS

	Conforms to relevant safety standards
	To reduce the risk of injury, the user must read and understand this manual before using this product.
	Wear eye protection.
	Wear mask protection in dust condition.
	Wear ear protectors. Exposure to noise can cause hearing loss.
	Do not dispose of old appliances with domestic rubbish.
	Class II, double isolation(only for charger).
	Do not expose the the battery to water.
	Do not incinerate the battery or charger.
	Ambient temperature of 40 °C max (only for the battery).
	Use the battery and charger Indoor use only.
	Recycling.

3. YOUR PRODUCT

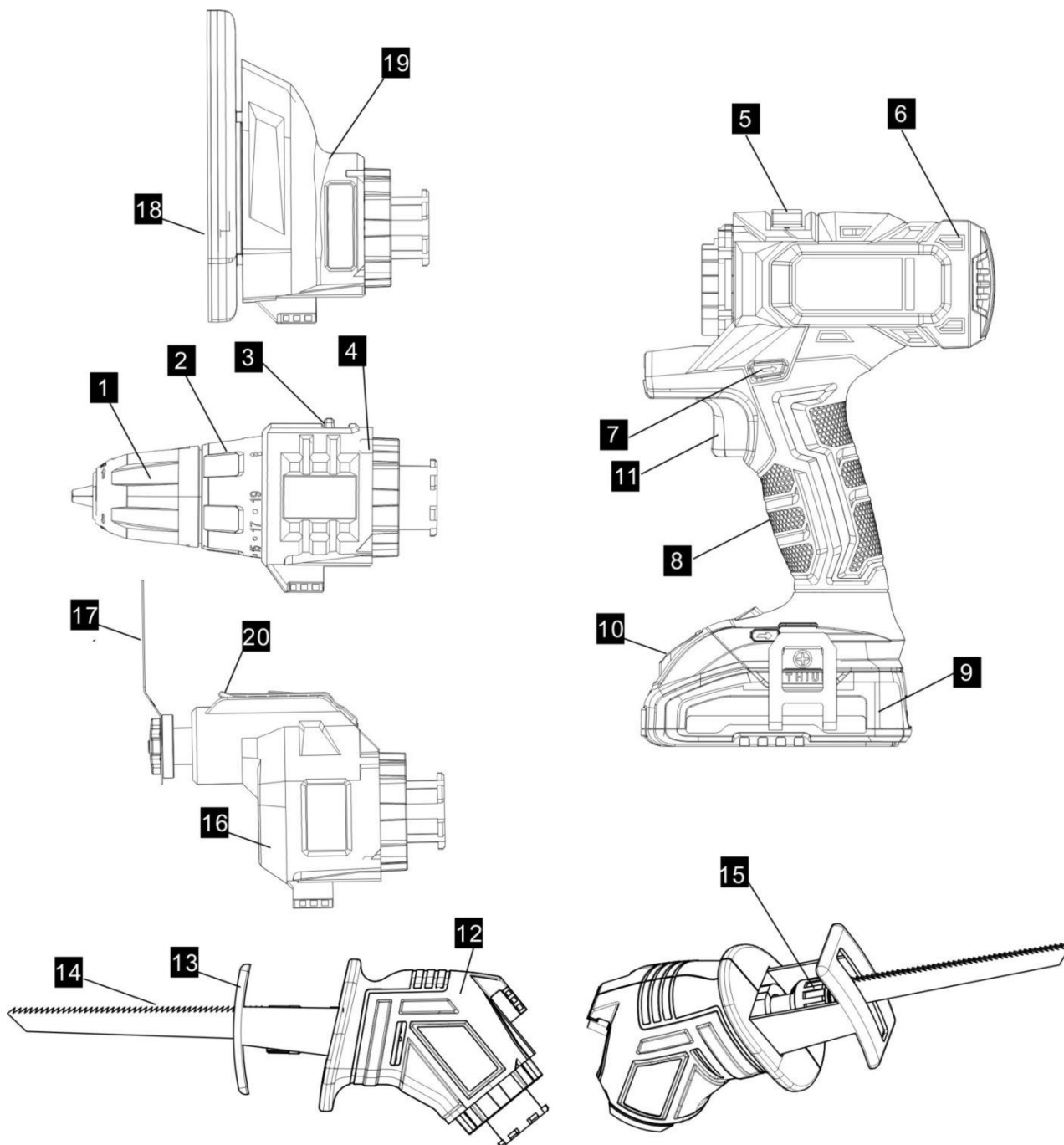

- | | | |
|---|----------------------------------|----------------------------------|
| 1. Keyless chuck | 8. Handle | 15. Lever for unlocking sawblade |
| 2. Torque adjustment ring | 9. Rechargeable battery | 16. Multi-tools attachment |
| 3. Gear selection switch | 10. Unlock button for battery | 17. Stainless scraper |
| 4. Drill attachment | 11. On/off switch | 18. Sanding plate |
| 5. Unlocking lever for appliance attachment | 12. Reciprocating Saw attachment | 19. Multi-sander attachment |
| 6. Motor unit | 13. Footplate | 20. Quick release lever |
| 7. Direction switch | 14. sawblade | |

4. PACKAGE CONTENT LIST

- Remove all packaging materials.
- Remove remaining packaging and packing inserts (if included).
- Check that the package contents are complete.
- Check the appliance, the power cord, the power plug of charger and all accessories for transportation damage or not.
- Keep the packaging materials as far as possible until the end of the warranty period. Then take it to your local waste disposal system.



WARNING! Packaging materials are not toys! Children must not play with plastic bags! There is a danger of suffocation!

Accessories:

- Drill bits (1,5/2/3/4/5/6 mm) ,3 screwing bits (25mm) ,Bit holder
- Abrasives for mouse sander (2*60gr / 2*120gr & 1*240)
- Accessories for multi tool: 1pc stainless scraper; 1pc stainless blade;1pc sanding pad; 2pcs sanding paper for wood and meta
- Accessories for reciprocating Saw:1pc 150mm wood blade
- With 1 battery 2Ah + 1.5A fast charger

Note: If any parts are missing or damaged, please contact your dealer.

5. TECHNICAL DATA

Rated voltage (direct current)	18V d.c.
No load speed of motor	0-21000/min
Drill function	No load speed:0-350/0-1400min ⁻¹ 22+1 settings, 30 N.m torque, 13mm double- sleeve Cutting depth: Wood: 25mm, metal:10mm
	Sound pressure level (LpA) 79.2 dB(A),K=5 dB(A) Sound power level (LWA) 90.2 dB(A),K=5 dB(A) Vibration (ah): <2.5m/s ² , K=1.5m/s ²
Reciprocating Saw function	No load speed: 0-3000/min, Stroke length:15mm
	Sound pressure level (LpA) 92.8 dB(A) K= 3 dB(A) Sound power level (LWA)103.8 dB(A) K=3 dB(A) Vibration: "Sawing board" mode: ah, B=6.1m/s ² , K=1.5m/s ² ; "Sawing wood beams " : ah, WB= 8.4m/s ² , K=1.5 m/s ² .
Sander function	No load speed:0-10000/min. Sanding pad 138X97mm
	Sound pressure level (LpA) 90.1 dB(A) K=3 dB(A) Sound power level (LWA)101.1 dB(A), K=3 dB(A) Vibration (ah)4.7 m/s ² , K=1.5 m/s ²
Multi-tool function	Oscillation:0-21000/min. angle 3 degree
	Sound pressure level (LpA) 91.7 dB(A),K=3 dB(A)

- 6) Frequently monitor the charger and battery pack while connected.
- 7) Unplug the charger and disconnect it from the battery pack when finished.
- 8) Allow the battery pack to cool completely before using it.
- 9) Store the charger and battery pack indoors, out of reach of children.

 **NOTE:** If the battery does not fit properly, disconnect it and confirm that the battery pack is the correct model for this charger as shown on the specification chart. Do not charge any other battery pack or any battery pack that does not securely fit the charger.

 **NOTE:** If battery is hot after continuous use in the tool, allow it to cool down to room temperature before charging. This will extend the life of your batteries.

 **NOTE:** Remove battery pack from charger stand which use your thumb or fingers, press the battery's release button in and pull the battery pack off at the same time.

Battery capacity indicator

There are battery capacity indicators on the battery pack; you can check the capacity status of the battery if you squeeze the button. Before using the machine, please press switch trigger to check if the battery is full enough for properly working.

 **WARNING!** Before making any adjustments ensure the drill is switched off with the direction of rotation selector in the center position

1. Remove the battery: press the battery release latch in and at the same time pull the battery pack off.
2. To insert the battery, push the battery pack onto the contacts of the tool.

6.2 REPLACING THE APPLIANCE ATTACHMENT

 **WARNING!**

Secure the appliance against switching on (see "Switching on/off") or remove the rechargeable battery from the appliance. There is an injury hazard if the device is switched on accidentally.

Removing appliance attachment

- 1) Push the unlocking lever (5) into position as far as the stop and then hold it in this position.
- 2) Pull the unlocked appliance attachment off.
- 3) Allow the unlocking lever (5) to slide back into position.

Fitting appliance attachment

- 4) Push the appliance attachment along the guide rail into the motor unit (6). It locks into place audibly.
- 5) Allow the unlocking lever (5) to slide back into position.
- 6) Check that the appliance attachment is secure by pulling on it.

6.3 SWITCHING ON/OFF

1. Switching on: Press the on/off switch (11). By using the on/off switch (11) you can progressively control the speed. Gentle pressure: low speed Increase pressure: higher speed.
2. Switching off: Release the on/off switch (11). If you place the direction switch (7) in the middle position, the device is secured against being switched on.

6.4 MOTOR UNIT WITH DRILL ATTACHMENT

Changing the tool

- 1). Rotate the keyless chuck (1) counterclockwise, until the drill chuck aperture is large enough to accommodate the tool.
- 2). Insert the tool as far as possible into the keyless chuck (1).
- 3). Rotate the keyless chuck (1) clockwise in order to clamp the tool.
- 4). To remove the tool again, rotate the keyless chuck (1) and pull out the tool.

Choice of gear



WARNING! Stop appliance before changing gear to avoid the tool damage.

- 1). Wait for the appliance to come to a standstill.
- 2) Slide the gear selector (3) into the required position:
 - 1=> low speed
 - 2=>high speed

Set the direction of rotation

The appliance's direction of rotation can be changed with the rotational direction switch.

- 1) Wait for the appliance to come to a standstill.
- 2) Push the rotational direction speed (7) into the desired position:
 - Clockwise rotation: to drill and screw in screws.
 - Anticlockwise rotation: to unscrew screws.
- 3) If you place the direction switch (7) in the middle position, the device is secured against being switched on.

Torque adjustment

You can preselect the maximum torque.

The torque settings are labeled 1 - 22 + 

- 1) Wait for the appliance to come to a standstill.
- 2) Turn the torque adjusting ring (2) to select the desired torque:

Screws: Steps 1 - 22; Drilling: Step 

- 3) Start with a lower torque step and increase as required.

Note: The necessary torque is dependent on:

- The type and hardness of the material to be treated;
- The type and length of the screws used.

6.5 MOTOR UNIT WITH SANDER ATTACHMENT



WARNING! Secure the appliance against switching on (see "Switching on/off"). If the appliance is switched on accidentally, there is a danger of injury!

Attaching/removing sanding sheet

The sanding plate is fitted with Velcro for rapid attachment of the sanding sheet.

Attaching sanding sheet.

1) Press the sanding sheet evenly onto the sanding plate. Ensure that the holes in the sanding sheet are placed above the openings in the sanding plate.

Removing sanding sheet

2) Simply pull the sanding sheet off the sanding plate.

Connecting dust extraction

You can reduce dust production during sanding by attaching a dust extraction system.

1 Push the adaptor into the opening on the sander attachment as far as the stop.

2 Connect a dust extractor suction hose to the adaptor.

Note: If necessary, you can connect the suction hose of a vacuum cleaner without reducer to the adapter

6.6 MOTOR UNIT WITH RECIPROCATING SAW ATTACHMENT

Installing/changing the blade



WARNING! Secure the appliance against switching on (see “Switching on/off”). If the appliance is switched on accidentally, there is a danger of injury!



Caution, risk of Injury!

- Do not use any blunt or bent blades or blades which are damaged in any other way.

- Always insert a suitable sawblade.

Installing the blade:

1) Push the lever (15) for sawblade unlocking upwards as far as the stop. Push the sawblade shaft into the sawblade mounting slot.

2) To unlock, release the lever, it will return to the initial position.

3) Check that the sawblade is secure by pulling on it. Removing the sawblade:

4) Press the lever (15) for sawblade unlocking upwards as far as the stop and then pull the sawblade out of the sawblade mounting.

Operating the Reciprocating Saw

1) Before switching the appliance on, ensure it is not in contact with the workpiece.

2) Turn the appliance on. By using the on/off switch (11) you can progressively control the stroke rate.

Gentle pressure: low stroke rate.

Greater pressure: higher stroke rate.

The on/off switch cannot be locked.

3) Place the footplate (13) on the workpiece.

4) Cut with a uniform forward motion.

5) After completion of the work, first remove the blade from the saw cut and then switch the appliance off.

6.7 MOTOR UNIT WITH MULTIFUNCTION TOOL

Changing the tool



WARNING! Secure the appliance against switching on (see “Switching on/off”). If the appliance is switched on accidentally, there is a danger of injury!

1) Push the lever for tool unlocking upwards as far as the stop.

- 2) Pull the unlocked tool holder off forwards.
- 3) Place the required tool on the arbor. 12 different positions are possible.
- 4) Press the tool holder back into the central mounting.
- 5) Push the lever for tool unlocking forwards again. The tool holder is fixed to the tool.

Attaching/removing sanding sheet

The delta sanding plate is fitted with Velcro for rapid attachment of the sanding sheet.

Attaching sanding sheet

- 1) Press the sanding sheet evenly onto the delta sanding plate. Ensure that the holes in the sanding sheet are placed above the openings in the sanding plate.

Removing sanding sheet

- 2) Simply pull the sanding sheet off the delta sanding plate.

Practical tips

When working with the appliance, always wear suitable clothing and appropriate protective equipment.

Prior to each use it must be ensured that the appliance is working correctly.

Personal protective equipment and a fully functional appliance reduce the risk of injuries and accidents.

Sawing

- Use only undamaged sawblades in perfect condition. Only use metal sawblades for metalworking.
- Ensure your stance is stable and hold the appliance tightly with both hands and away from your body.
- Before sawing the workpiece, check for hidden foreign objects such as nails, screws. These must be removed.
- Plunge cuts may only be made in soft material such as wood or plasterboard.

Selection of sawblade

Wood sawblade for wood, plastic, plasterboard

Metal sawblade for metal sheets, profiles and tubes

Sanding

- Use a dust extraction system when sanding with the multi-sander attachment.
- Move the appliance against the workpiece once it is switched on.
- Clean the sanding plate before you attach a sanding sheet.
- Only work with sanding sheets in perfect condition to achieve good sanding results.
- Work using low and even pressure. This protects the appliance and the sanding sheet.
- Do not use the same sanding sheet to sand different materials (e.g. metal and then wood).

Selection of sanding sheet

Grain size P application

P 60 for pre-sanding rough wood surfaces

P 80/120 for plain sanding

P 240 for fine sanding of primed and painted surfaces

Scraping

- Use a high oscillation rate when scraping.
- Work using low pressure and at a low angle in order not to damage the substrate material.

7. CLEANING/MAINTENANCE

Note: Repair and servicing work not described in this manual should always be carried by our Service Centre. Use only original parts. Switch off the device and remove the battery from the device before working with or transporting it.

Note: The following cleaning and servicing should be done regularly. This will ensure a long and reliable service life.

Cleaning:

Do not spray the appliance with water and do not immerse it in water. Electric shock hazard!

Keep clean the ventilation slots, motor housing and handles of the appliance. Use a damp cloth or a brush.

Do not use cleaning agents or solvents. You may otherwise irreparably damage the appliance.

Maintenance

- The equipment is maintenance free.

8. STORAGE

- Store the device in a dry place well out of reach of children.
- Remove the battery before storing the unit for longer periods of time (e.g. hibernation).
- Store the battery only in a partially charged state. The state of charge should be 40 – 60 % over a longer storage period (two LED lights of the charge status indicator (9a) light up).
- During a longer storage period, check the state of charge of the battery and recharge if necessary roughly every 3 months.
- In order to keep the battery well charged, avoid exposing the appliance to extreme heat or cold in storage.
- Store the equipment between 10° C and 25° C. During storage, avoid extreme cold or heat so the battery does not lose power.

9. DISPOSAL



Electrical products should not be discarded with household products. According to the European Directive 2012/19/EU on waste electrical and electronic equipment and its implementation into national law, electrical products used must be collected separately and disposed of at collection points provided for this purpose. Talk with your local authorities or dealer for advice on recycling.

BATTERY PACK



This product contains Li-ion. To preserve natural resources, please recycle or dispose of batteries properly. Local, state or federal laws may prohibit disposal of Li-ion batteries in ordinary trash. Consult your local waste authority for information regarding available recycling and/or disposal options.

10. DELARATION OF CONFORMITY



BUILDER SAS

32, rue Aristide Bergès - ZI 31270 Cugnaux - France,

declares that,

Product: CORDLESS TOOL 18V 4 IN 1

Trade mark: FEIDER

Model: FPVSS18V4IN1

Serial number: 20220611498-20220613997

Is in conformity with the essential requirements and other relevant provisions of the applicable European Directives, based on the application of European harmonized standards. Any unauthorized modification of the apparatus voids this declaration.

European Directives (including, if applicable, their amendments up to the date of signature);

RoHS directive 2011/65/EU + (EU) 2015/863

2014/30/EU; 2006/42/EC

LVD Directive 2014/35/UE

European harmonized standards

EN 62841-1: 2015; EN 62841-2-1:2018+A11:2019

EN 62841-2-4:2014; EN 62841-2-11: 2016+A1:2020

EN 55014-1:2017+A11:2020; EN 55014-2:2015; EN55014:2017

EN 61000-3-2:2014; EN 61000-3-3:2013

EN 62233:2008

EN 60335-2-29:2004+A2:2010+A11:2018

EN 60335-1:2012+A11:2014+A13:2017+A1:2019+A2:2019+A14:2019

Cugnaux, 18/04/2022

Philippe MARIE / PDG

Responsible of the technical file: Mr. Olivier Patriarca

11. WARRANTY



WARRANTY

The manufacturer guarantees the product against defects in material and workmanship for a period of 2 years from the date of the original purchase. The warranty only applies if the product is for household use. The warranty does not cover breakdowns due to normal wear and tear.

The manufacturer agrees to replace parts identified as defective by the designated distributor. The manufacturer does not accept responsibility for the replacement of the machine, in whole or in part, and/or ensuing damage.

The warranty does not cover breakdowns due to:

- insufficient maintenance.
- abnormal assembly, adjustment or operations of the product.
- parts subject to normal wear and tear.

The warranty does not extend to:

- shipping and packaging costs.
- using the tool for a purpose other than that for which it was designed.
- the use and maintenance of the machine done in a manner not described in the user manual.

Due to our policy of continuous product improvement, we reserve the right to alter or change specifications without notice. Consequently, the product may be different from the information contained therein, but a modification will be undertaken without notice if it is recognized as an improvement of the preceding characteristic.

READ THE MANUAL CAREFULLY BEFORE USING THE MACHINE.

When ordering spare parts, please indicate the part number or code, you can find this in the spare parts list in this manual. Keep the purchase receipt; without it, the warranty is invalid. To help you with your product, we invite you to contact us by phone or via our website:

- **+33 (0)9.70.75.30.30**
- **<https://services.swap-europe.com/contact>**

You must create a "ticket" via the web platform.

- Register or create your account.
- Indicate the reference of the tool.
- Choose the subject of your request.
- Describe your problem.
- Attach these files: invoice or sales receipt, photo of the identification plate (serial number), photo of the part you need (for example: pins on the transformer plug which are broken).



12. PRODUCT FAILURE

WHAT TO DO IF MY MACHINE BREAKS DOWN?

If you bought your product in a store:

a) Empty the fuel tank if your product has one.

b) Make sure that your machine is complete with all accessories supplied, and clean! If this is not the case, the repairer will refuse the machine.

Go to the store with the complete machine and with the receipt or invoice.

If you bought your product on a website:

a) Empty the fuel tank if your product has one.

b) Make sure that your machine is complete with all accessories supplied, and clean! If this is not the case, the repairer will refuse the machine.

c) Create a SWAP-Europe service ticket on the site: <https://services.swap-europe.com> When making the request on SWAP-Europe, you must attach the invoice and the photo of the nameplate (serial number).

d) Contact the repair station to make sure it is available before dropping of the machine.

Go to the repair station with the complete machine packed, accompanied by the purchase invoice and the station support sheet downloadable after the service request is completed on the SWAP-Europe site

For machines with engine failure from manufacturers BRIGGS & STRATTON, HONDA and RATO, please refer to the following instructions.

Repairs will be done by approved engine manufacturers of these manufacturers, see their site:

- <http://www.briggsandstratton.com/eu/fr>
- <http://www.honda-engines-eu.com/fr/service-network-page;jsessionid=5EE8456CF39CD572AA2AEEDFD290CDAE>
- <https://www.rato-europe.com/it/service-network>

Please keep your original packaging to allow for after-sales service returns or pack your machine with a similar cardboard box of the same dimensions.

For any question concerning our after-sales service you can make a request on our website <https://services.swap-europe.com>

Our hotline remains available at +33 (9) 70 75 30 30.



13. WARRANTY EXCLUSIONS

THE WARRANTY DOES NOT COVER:

- Start-up and setting up of the product.
- Damage resulting from normal wear and tear of the product.
- Damage resulting from improper use of the product.
- Damage resulting from assembly or start-up not in accordance with the user manual.
- Breakdowns related to carburetion beyond 90 days and fouling of carburetors.
- Periodic and standard maintenance events.
- Actions of modification and dismantling that directly void the warranty.
- Products whose original authentication marking (brand, serial number) has been degraded, altered or withdrawn.
- Replacement of consumables.
- The use of non-original parts.
- Breakage of parts following impacts or projections.
- Accessories breakdowns.
- Defects and their consequences linked to any external cause.
- Loss of components and loss due to insufficient screwing.
- Cutting components and any damage related to the loosening of parts.
- Overload or overheating.
- Poor power supply quality: faulty voltage, voltage error, etc.
- Damages resulting from the deprivation of enjoyment of the product during the time necessary for repairs and more generally the costs related to the immobilization of the product.
- The costs of a second opinion established by a third party following an estimate by a SWAP-Europe repair station
- The use of a product which would show a defect or a breakage which was not the subject of an immediate report and/or repair with the services of SWAP-Europe.
- Deterioration linked to transport and storage*.
- Launchers beyond 90 days.
- Oil, petrol, grease.
- Damages related to the use of non-compliant fuels or lubricants.

* In accordance with transport legislation, damage related to transport must be declared to carriers within 48 hours maximum after observation by registered letter with acknowledgement of receipt.

This document is a supplement to your notice, a non-exhaustive list.

Attention: all orders must be checked in the presence of the delivery person. In case of refusal by the delivery person, it you must simply refuse the delivery and notify your refusal.

Reminder: the reserves do not exclude the notification by registered letter with acknowledgement within 72 hours.

Information:

Thermal devices must be wintered each season (service available on the SWAP-Europe site). Batteries must be charged before being stored.



BUILDER SAS

32, rue Aristide Bergès - ZI 31270 Cugnaux – France

Made in PRC 2022